

HD SERIES

Digital RH and RH/T Transmitters



NOTICE

- This product is not intended for life or safety applications.
- Do not install this product in hazardous or classified locations.
- Read and understand the instructions before installing this product.
- Turn off all power supplying equipment before working on it.
- The installer is responsible for conformance to all applicable codes.

No responsibility is assumed by Veris Industries for any consequences arising out of the use of this material.

PRODUCT IDENTIFICATION

Accuracy	NIST	Output	US or EU	Temp.
HD <input type="checkbox"/>	<input type="checkbox"/>	<input type="checkbox"/>	<input type="checkbox"/>	<input type="checkbox"/>
1 = 1%	N = NIST	M = 4-20mA	S = Standard	T = Temp
2 = 2%	X = None	V = 0-5V/0-10VDC	C = CE	X = No Temp (Stop here)
3 = 3%				
5 = 5%				

Humidity Transmitter Combination

Sensor Type	Range	OPTION Temp Cert
<input type="checkbox"/>	<input type="checkbox"/>	<input type="checkbox"/>
= Transmitter	1 = -40° to 50°C (-40° to 122°F)	Blank = None
	2 = 0° to 50°C (32° to 122°F)	1 = 1pt Cal
		2 = 2pt Cal

Humidity RTD/Thermistor Combination

Sensor Type	OPTION Temp Cert
<input type="checkbox"/>	<input type="checkbox"/>
B = 100R Platinum, RTD	Blank = None
C = 1k Platinum, RTD	1 = 1pt Cal
D = 10k T2, Thermistor	2 = 2pt Cal
E = 2.2k, Thermistor	
F = 3k, Thermistor	
G = 10k CPC, Thermistor	
H = 10k T3, Thermistor	
J = 10k Dale, Thermistor	
K = 10k with 11k shunt, Thermistor	
M = 20k NTC, Thermistor	
N = 1800 ohm TAC, Thermistor	
Q = 1uA/°C, Linitemp	
R = 10k US, Thermistor	
S = 10k 3A 221, Thermistor	
T = 100k, Thermistor	
U = 20k "D", Thermistor	

SPECIFICATIONS

Input Power: *	
Voltage Models	12-30VDC/24VAC, 15mA max.
mA Model	loop powered 12-30VDC only, 30mA max.
Output Power:	
Voltage Models	3-wire, observe polarity
mA Model	2-wire, not polarity sensitive (clipped and capped)
Humidity:	
HS Element	Digitally profiled thin-film capacitive (32-bit mathematics) U.S. Patent No. 5,844,138
Accuracy @ 25°C from 10-80% RH**	±1%, ±2%, ±3%, or ±5% (specify); Multi-point calibration, NIST traceable
Temperature Effect, Duct Model	+0.1% RH/°C above or below 25°C (typical)
Temperature Effect, Outdoor Model	mA version: (0.0013x%RHx(T°C-25)); Volt version: (0.0015c%RHxT°C-25) - (%RHx0.0008xabs(T°C-25))
Scaling	0-100%RH
Hysteresis	1.5% typical
Linearity	Included in Accuracy spec.
Reset Rate***	24 hours
Stability	±1% @ 20°C (68°F) annually, for two years
Temperature:	
Optional Temperature Transmitter Output	Digital, 4-20mA (clipped and capped) or 0-5V/0-10V output; HD transmitter accuracy: ±0.5°C (±1.0°F) typical
Operating Environment:	
Operating Humidity Range	0 to 100% RH noncondensing
Operating Temperature Range	-40° to 50°C (-40° to 122°F)
Agency Approvals	EMC EN 50081-1, EN 50082-1, EN 61000-4-4, EN 61000-4-5, EN 61000-4-3, ENV 50204, EN 61000-4-6

* One side of transformer secondary is connected to signal common. Isolation transformer or dedicated power supply may be required.

** Specified accuracy with 24 VDC supplied power with rising humidity.

*** Reset Rate is the time required to recover to 50% RH after exposure to 90% RH for 24 hours.

RTD Thermistors are not compensated for internal heating of product.

To conform to EMC standards, shielded cabling and technical information is available from the factory upon request or is available on our website: www.veris.com

EMC Special Note: Connect this product to a DC distribution network or an AC/DC power adaptor with proper surge protection (EN 61000-6-1:2007 specification requirements).

INSTALLATION



Observe precautions for handling static sensitive devices to avoid damage to the circuitry that is not covered under the factory warranty.

1. Choose a location on the return air duct.
2. Drill a 7/8" diameter hole in the duct for the sensor probe.
3. Mount the junction box housing to the duct using self-tapping screws (included).
4. Insert the probe through the black swage fitting into the duct. Tighten the swage fitting.
5. Wire the probe (see the Wiring section). Leave wires at factory length to allow for a service loop (to remove the sensor from junction box for service without disturbing the conduit).

PRODUCT OVERVIEW

The HD Series duct-mounted humidity sensors provide high accuracy humidity monitoring with a fully replaceable HS element for easy field maintenance. NIST certified accuracy and temperature sensing capability are available. The HD is warranted for a period of five years.

DIMENSIONS

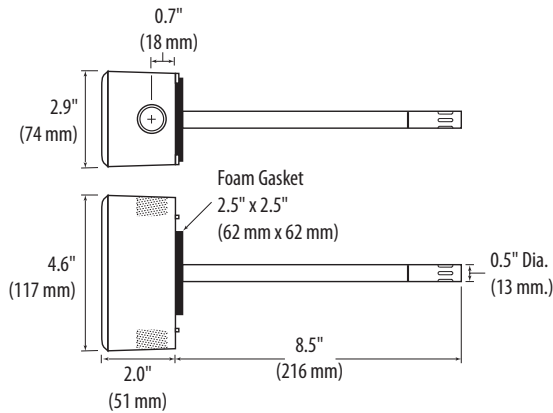

TROUBLESHOOTING

Problem	Solution
Filter tip does not fit on probe	HS element is backwards; reverse element.
Unit reads approx. 4.5mA	HS element is backwards; reverse element.
Unit reads 100% with new replacement sensor	Unit must be unpowered when installing a new sensor; interrupt sensor power to restart.
Accuracy appears incorrect	<ul style="list-style-type: none"> Remove HS element while powered and verify output goes to full scale. Verify voltage test leads on 4-20mA models corresponds to the 4-20mA output.

WIRING

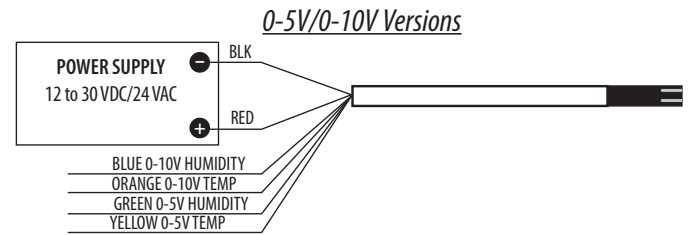

NOTE: For 24 VAC transformer powered applications, one side of transformer secondary is connected to common. Isolation transformer or dedicated power supply may be required.

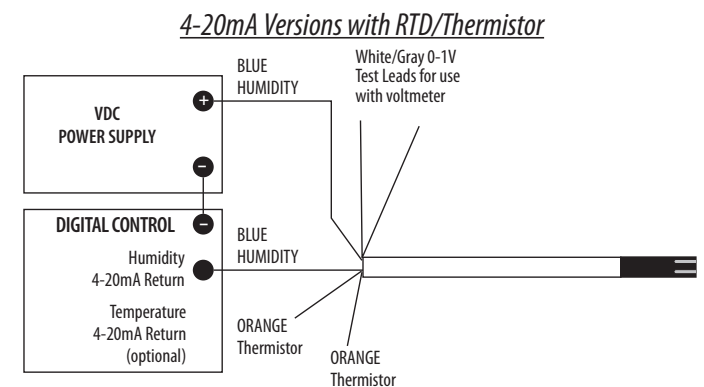
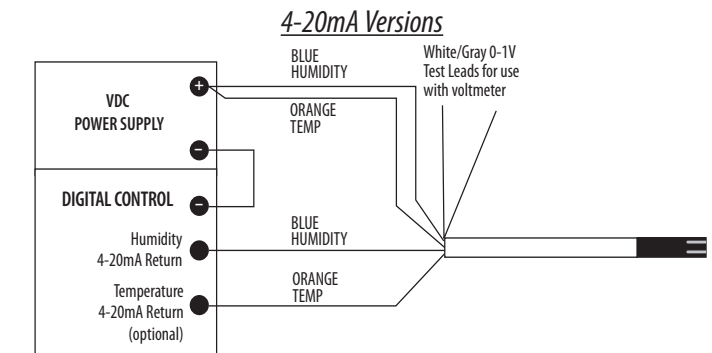
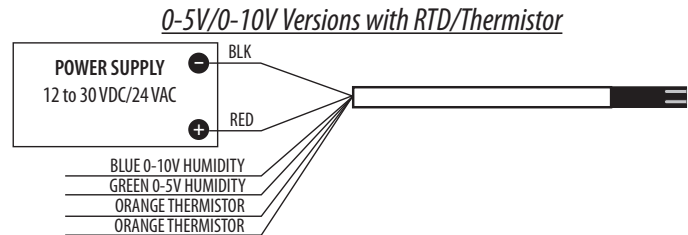

TEST POINTS AND SETUP VERIFICATION

SENSOR REPLACEMENT

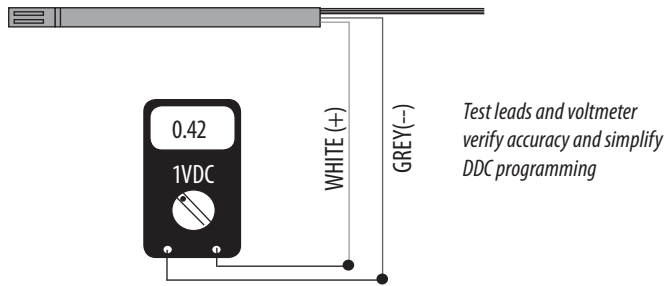

Voltmeter shows reading of 42% RH

For 4–20 mA versions: Test leads output 0-1 VDC corresponding to 0 to 100% RH sensor reading. For example, a 0.42 VDC output on test points equals 42% RH sensor reading. These test points also provide an output that verifies the motherboard accuracy when the HS element is removed. Connect test point leads to voltmeter only. This output is not suitable for connection to a DDC panel.

To check the motherboard functionality using the test leads, remove the sensor element. A 1.0 VDC reading verifies motherboard functionality.

To verify sensor accuracy, de-power the unit and insert a replacement HS element. Repower the unit and compare readings to the original sensor. For example, if test points read 0.40 VDC (40% RH) with the original sensor, and 0.45 VDC (45% RH) with the replacement sensor, then the original sensor is 5% off specification. This method of ensuring accuracy offers more precision than using slings or other devices, and it eliminates the need to manually adjust sensors to an unstable standard.

Note: Temperature, body sweat, and breath effect humidity. Ensure that conditions are stable to evaluate performance.

The filter may be washed using warm water and a soft brush. Do not attempt to scrub the HS element.

For 0-5V/0-10V versions, use the output as a test point and scale accordingly.



Observe precautions for handling static sensitive devices to avoid damage to the circuitry that is not covered under the factory warranty.

1. Disconnect power to the unit.
2. Remove the probe from the junction box by loosening the black swage nut and sliding it out.
3. Unscrew the filter on the tip of the probe. Set filter aside.
4. Remove the HS element by gently pulling from the pin connector. Do not attempt to remove the temperature sensor adjacent to the HS element (if equipped).
5. Place a new HS element onto the pin connector. Orient as shown, or the unit will not function (the filter will not screw on if the HS is inserted incorrectly).

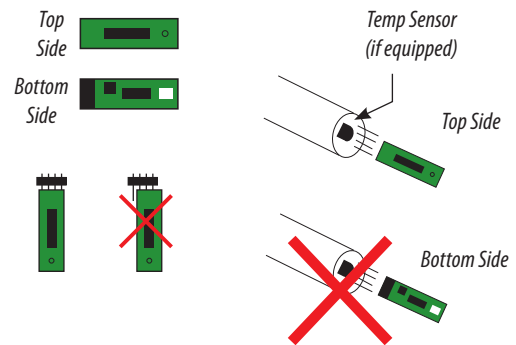

6. Replace the filter. Re-insert the probe into the junction box and tighten the swage nut.

Replacement HS Element Ordering Information

- HS2xxx Replacement 2% HS Element, Duct
- HS3xxx Replacement 3% HS Element, Duct
- HS4xxx Replacement 5% HS Element, Duct
- HS1Nx Replacement 1% HS NIST Element, Duct
- HS2Nx Replacement 2% HS NIST Element, Duct

Replacement filters are provided with all elements. Order the appropriate element accuracy to match the motherboard accuracy for compatibility.